

Product Code: WIN EFSNK C-BN

Revision: D2

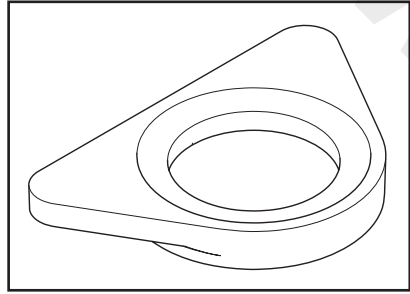

7

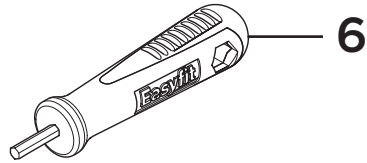

6



5

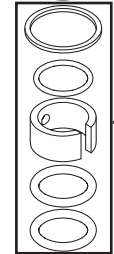
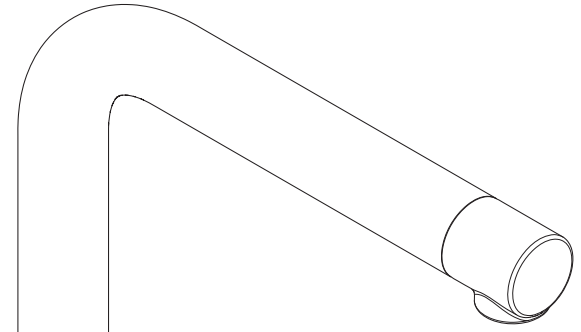

3



4

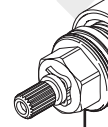
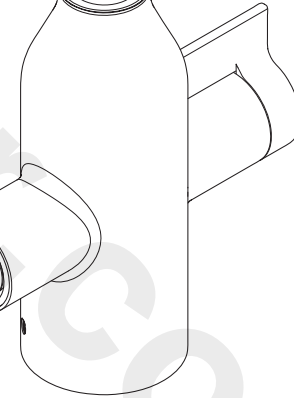

2

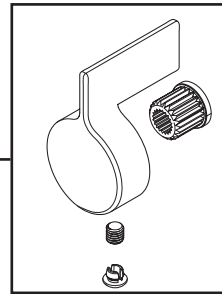

1

1	Handle Assembly with Adaptors
2	1/2" Ceramic Disc Valves (Pair)
3	Spout Seals Kit
4	M18 Coin-Slot Aerator
5	M5 x 8mm Grub Screw
6	EasyFit Tool
7	Reinforcing Plate
8	EasyFit Pack (Whole Page)
9	Isolation Valves (Pair)
10	Molykote Grease
11	1/2" BSP Flexible Tails (Pair)

Product Code: WIN EFSNK C-BN

Revision: D2

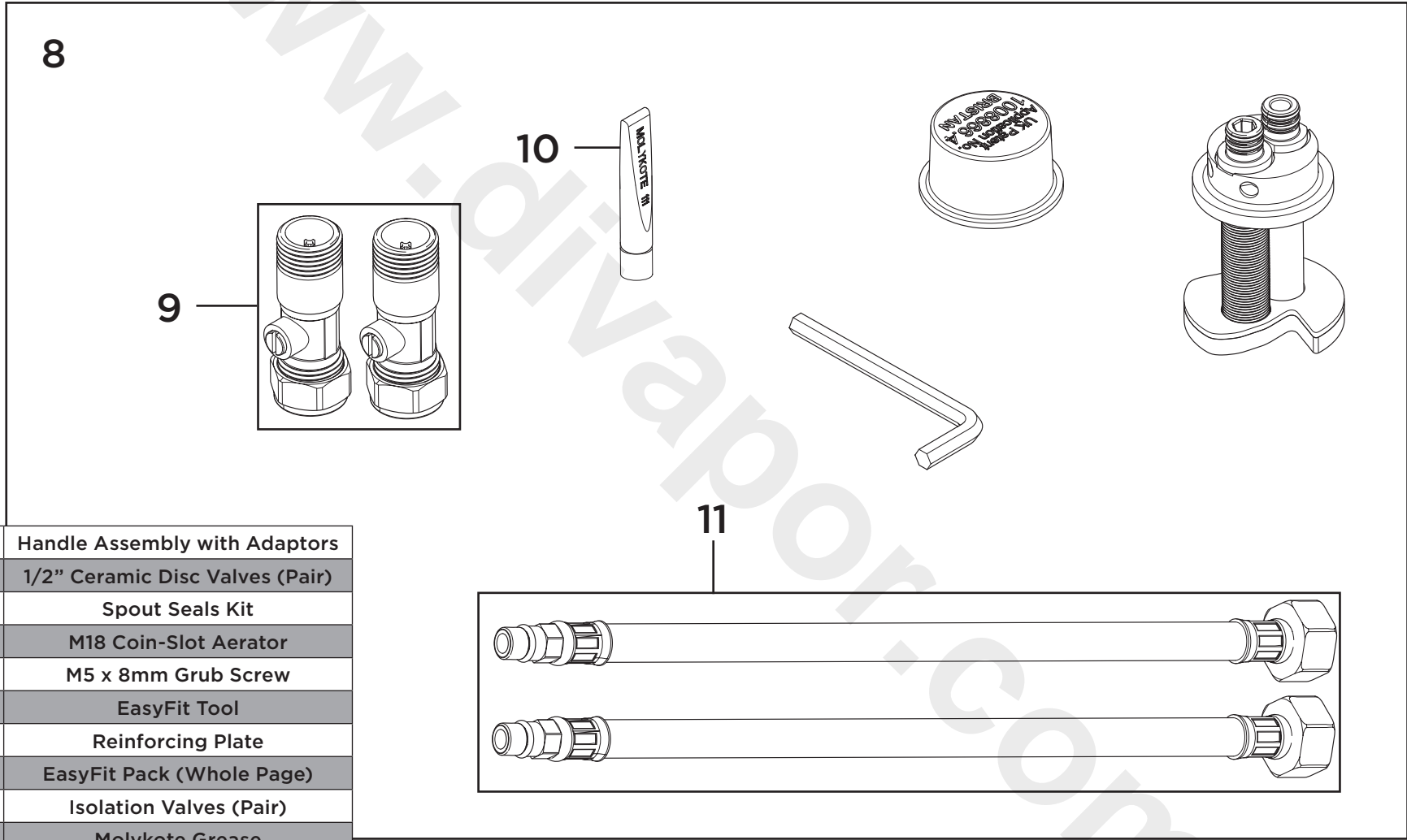

1	Handle Assembly with Adaptors
2	1/2" Ceramic Disc Valves (Pair)
3	Spout Seals Kit
4	M18 Coin-Slot Aerator
5	M5 x 8mm Grub Screw
6	EasyFit Tool
7	Reinforcing Plate
8	EasyFit Pack (Whole Page)
9	Isolation Valves (Pair)
10	Molykote Grease
11	1/2" BSP Flexible Tails (Pair)